

PARTIAL FOOT



AN ILLUSTRATIVE GUIDE

Design & Fabrication for a
Partial Foot Prosthesis that will...

- Reduce Friction
- Reduce Shearing
- Reduce Pressure
- Restore Propulsion
- Restore Limb Length
- Preserve Residual Limb

Introduction

This book is in response to requests from practitioners interested in a comprehensive prosthetic program to manage partial foot amputations.

Reimbursement Codes

Any reference to reimbursement codes are based on suggestions from practitioners using these techniques and are not suggested by Allard USA or validated by any reimbursement agency.

Copyright

This publication is © 2015 Allard USA and may not be copied or reproduced without specific authorization from Allard USA.

Applicable Amputation Levels

The concepts in this book apply to any partial foot amputation first ray or shorter.



About three-quarters of all PFA involve the toe(s) and/or disarticulation of the metatarsophalangeal joint.

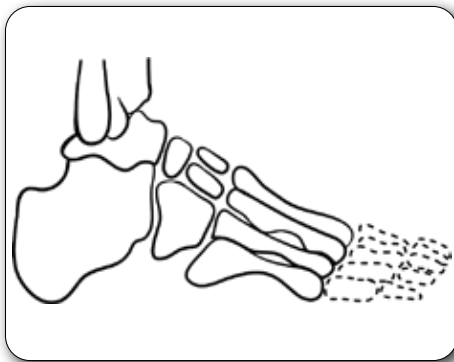

Metatarsophalangeal (MTP)

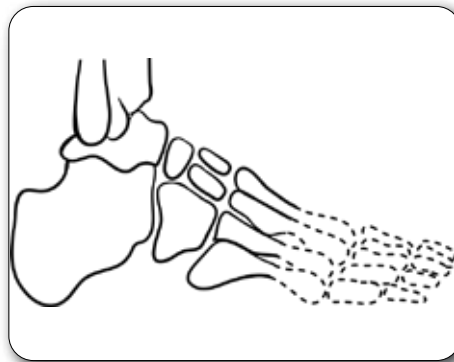

Transmetatarsal (TMT)

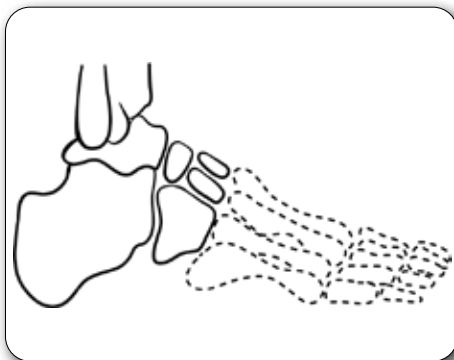

Tarsometatarsal (Lisfranc)

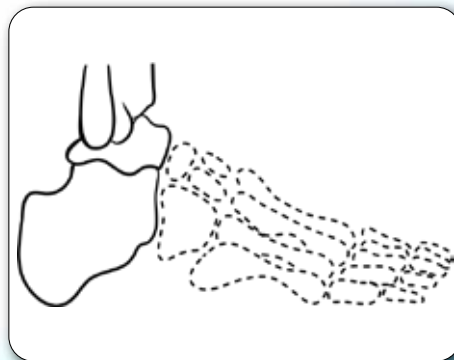

Transtarsal (Chopart)

PARTIAL FOOT CHALLENGES

1. Loss of Propulsion



Plantar Fascia Stretches

Toes Extend

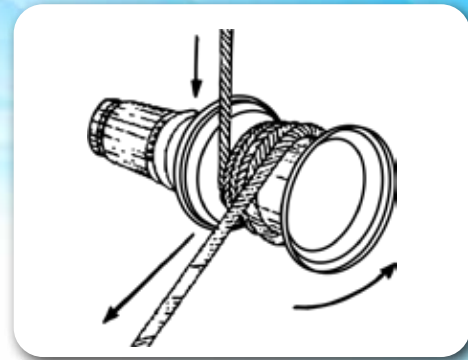
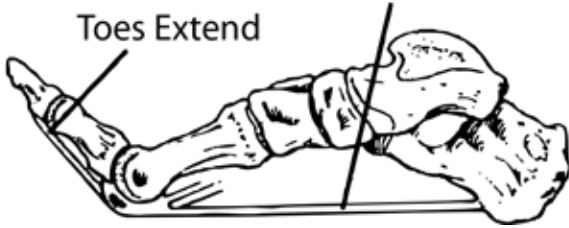

The term 'windlass' comes from sailing where it is the winch mechanism where the rope is wound around a drum, so in the foot the windlass is the plantar aponeurosis being wound around the metatarsal head.

Without the first ray windlass mechanism, the foot is considered "apropulsive"

2. Shearing Forces

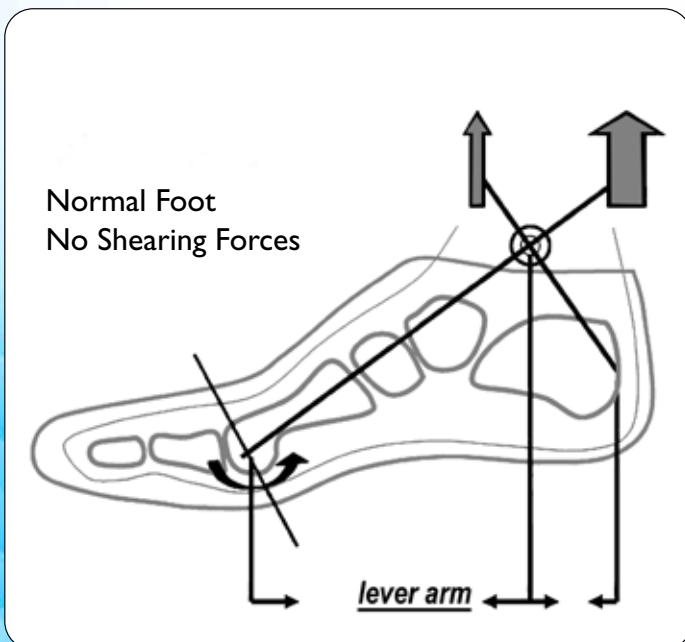

Normally calf group muscle strength is balanced by foot lever arm length.

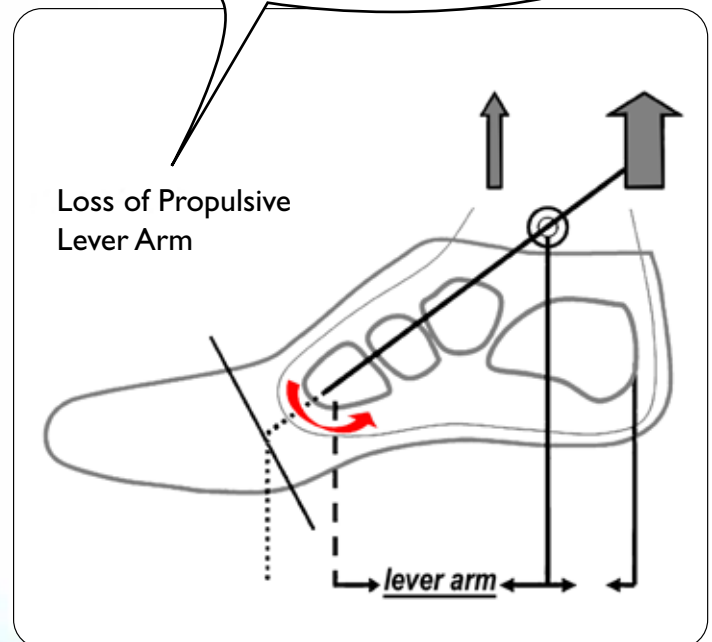

With amputation, muscles overpower the shortened lever arm, shearing connective tissue creating calluses.

Lever arm is the distance between the point of application of force and pivot.

OPTIONS

Foot Prosthesis or Short AFO



A foot prosthesis or short AFO with filler prosthesis cannot replace the lost propulsive lever arm.

Immobilization

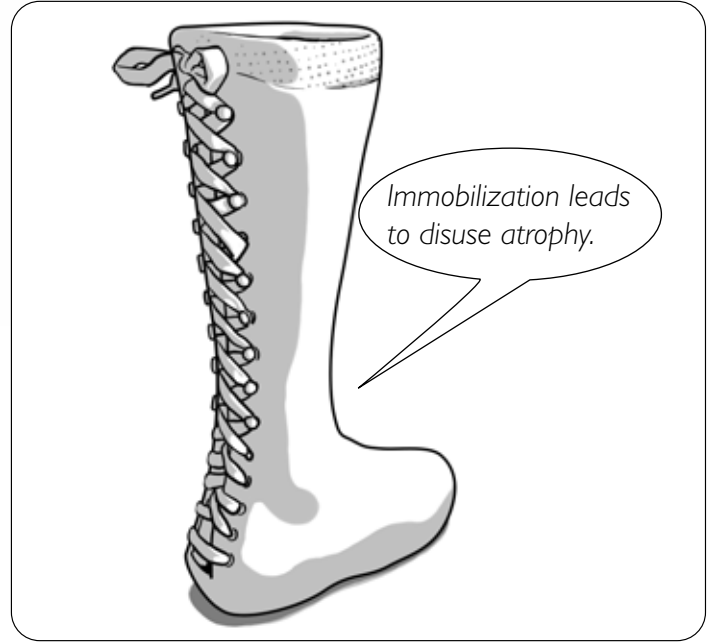

Immobilization can't help restore the propulsive lever arm and is proven to induce disuse atrophy.

Carbon Fiber Footplate

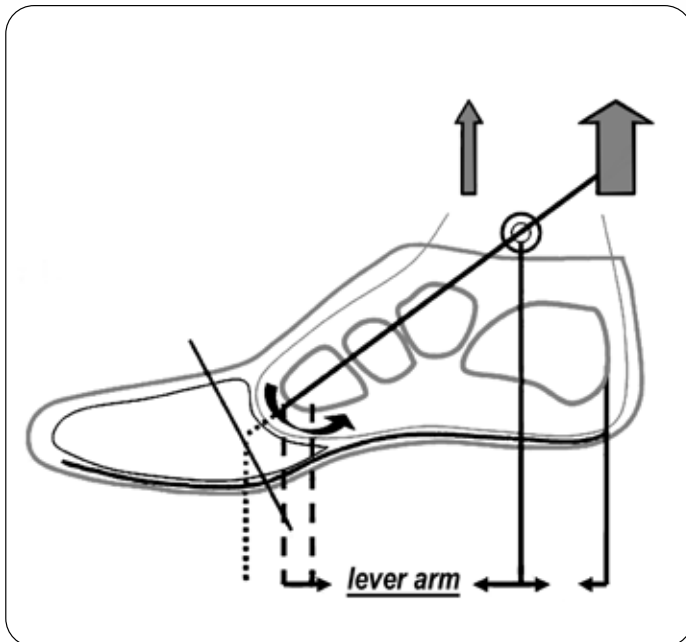

A carbon fiber footplate can only partially lengthen the propulsive lever arm, still allowing shearing leading to callus formation.

Carbon Fiber Footplate WITH a Lateral Strut

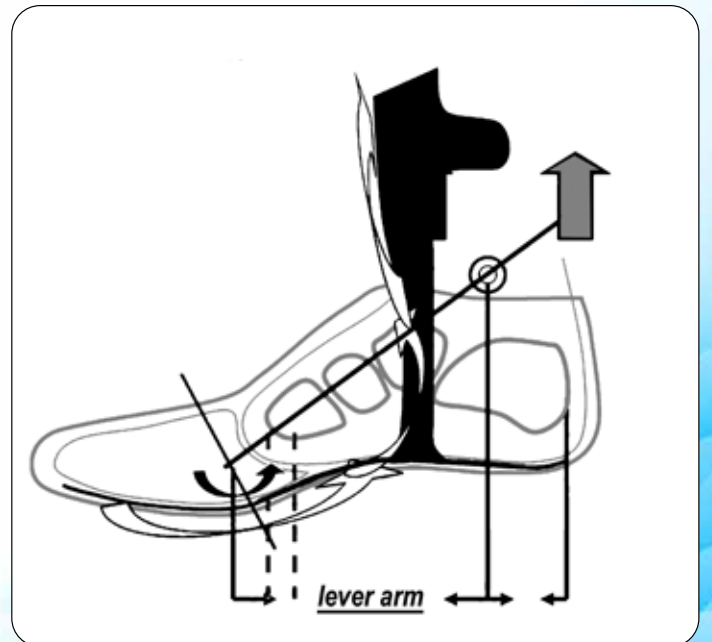

A footplate with a lateral strut leading into a tibial tubercle height pretilted shell can minimize or eliminate shearing forces by augmenting the shortened lever arm.

RESIDUAL FOOT PRESERVATION

Managing Friction

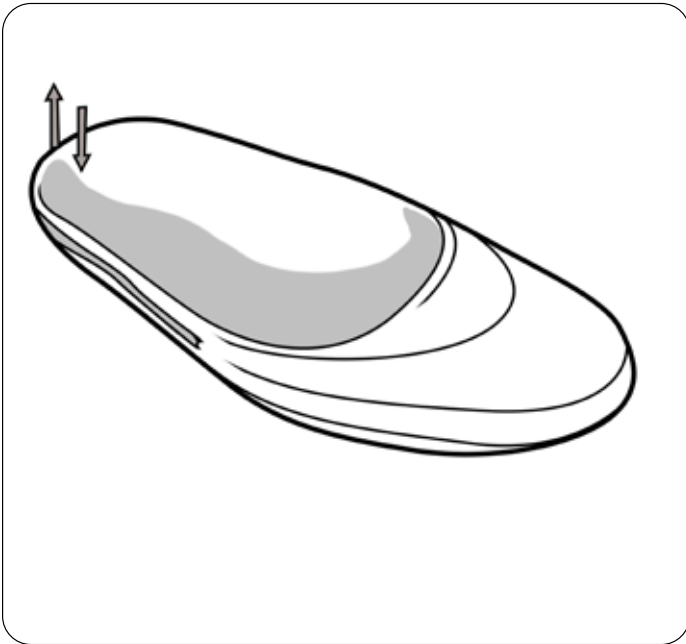

Friction can be managed by making sure the socket isn't too large and shoes aren't too big.

Managing Pressure

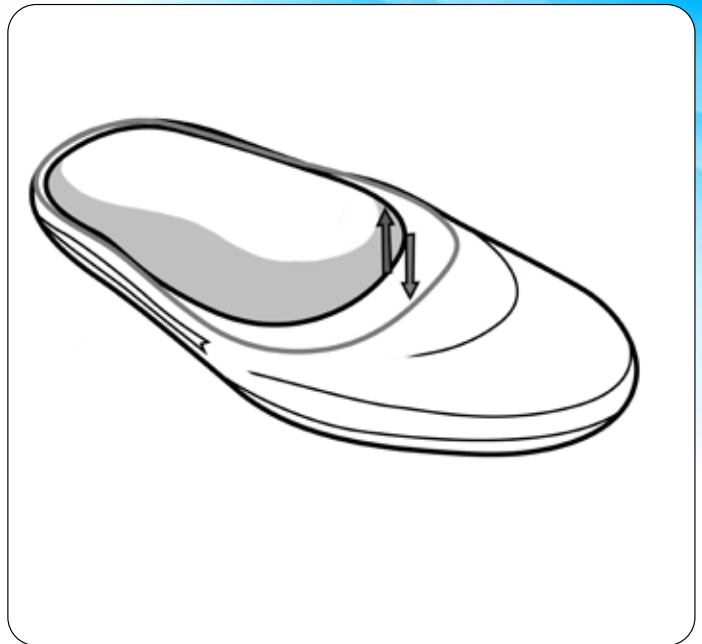

Pressure can be managed by making sure the socket isn't too small or shoes aren't too tight.

Residual Foot Preservation

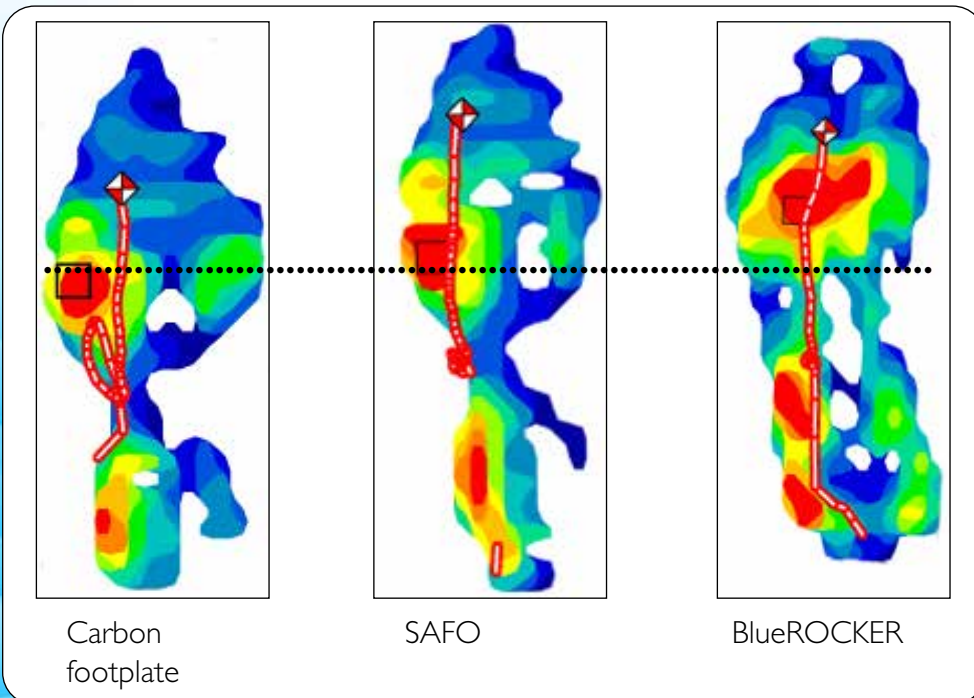

Carbon footplate

SAFO

BlueROCKER

Foot Preservation Summary

To optimize residual foot soft tissue integrity it is important to make sure it is protected from:

- Friction
- Pressure
- Shearing forces

Studies have shown destructive forces are distal to the residuum using BlueROCKER®, thereby preserving the residual foot.

MANAGING LIMB LENGTH

Range of Motion

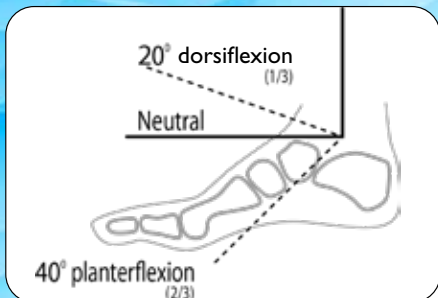

Nominal ROM at the ankle is 20° dorsiflexion and 40° plantarflexion.

Calcaneal Angle

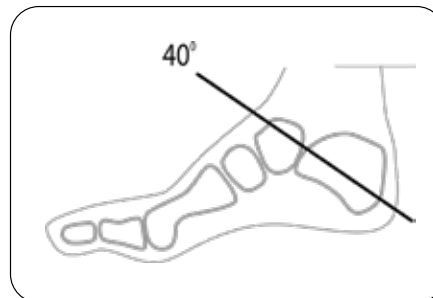

With the ankle at neutral, the normal calcaneal angle is 40°.

TMA

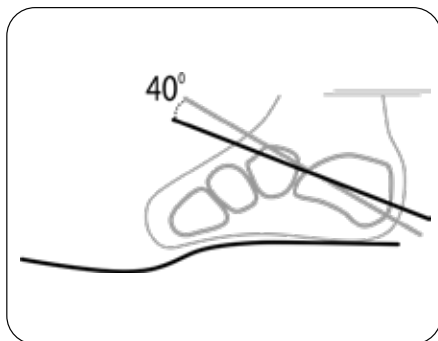

At TMA level amputation, expect 3/8 to 1/2" acquired limb length deficit.

LISFRANC

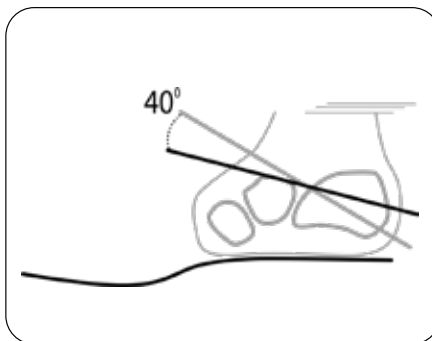

At Lisfranc level, expect 1/2 to 5/8" acquired limb length deficit.

CHOPART

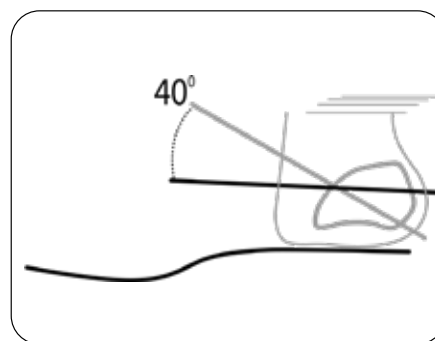

At Chopart level, expect 7/8 to 1 3/8" acquired LLD. Note acquired bulbous heel associated with ankle plantarflexion.

Determine leg length discrepancy

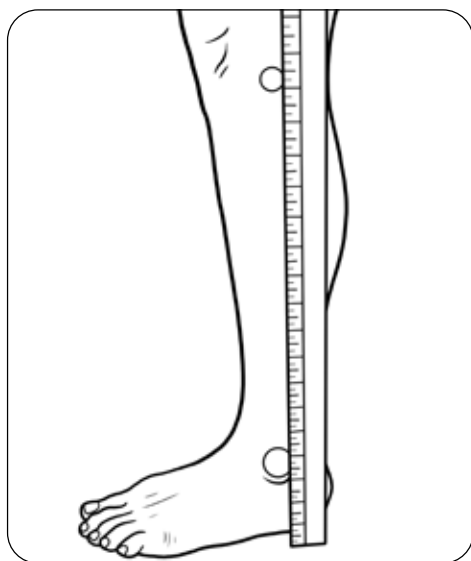

Measure limb length from fibular head to floor on both involved and uninvolved sides to determine acquired LLD.

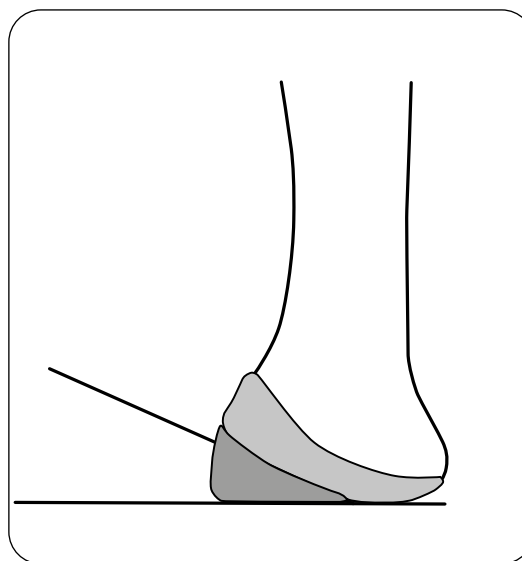

Determine if restoring calcaneal angle can resolve LLD. Have patient stand on end of 1X4 board and lift the other end. Note/document calcaneal angle.

MANAGING LIMB LENGTH

Adjust for leg length discrepancy



NOTE:

A calcaneal angle of 40° will return the ankle to neutral and should resolve any acquired LLD and eliminate or minimize an acquired bulbous heel.

Wedge anterior aspect of calcaneus to previous measurement. If LLD is not fully resolved, it will be necessary to post the heel section of the socket. See page 8, step 5 for illustration.

GAIT RESTORATION

Restore Propulsion

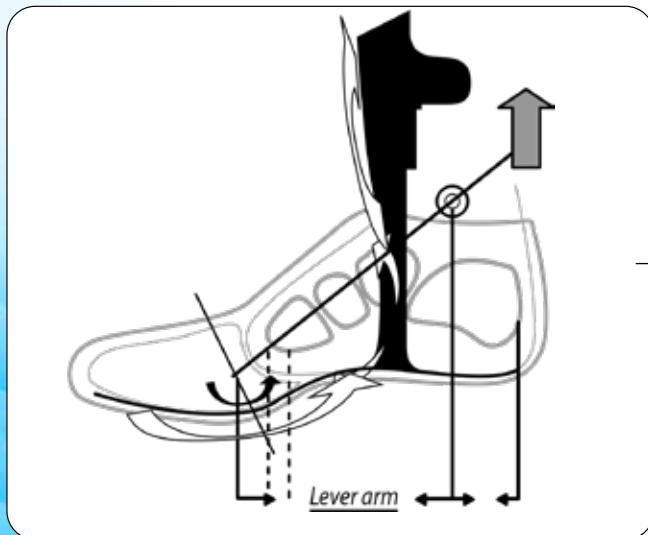

Tibial tubercle height pre-tibial shell, lateral strut and kinetic return footplate help restore propulsion.

Data show that at TMA level, the ankle loses 85% of propulsive power. At Lisfranc and Chopart, the loss is 100% due to lack of a propulsive lever arm.

Compensations include hip-hiking, trunk lean, shorter sound side step length, and increased trunk torsion to advance the involved side limb through space.

Management of any partial foot amputation requires restoration of the propulsive lever arm.

PROSTHESIS FABRICATION

1. Cast

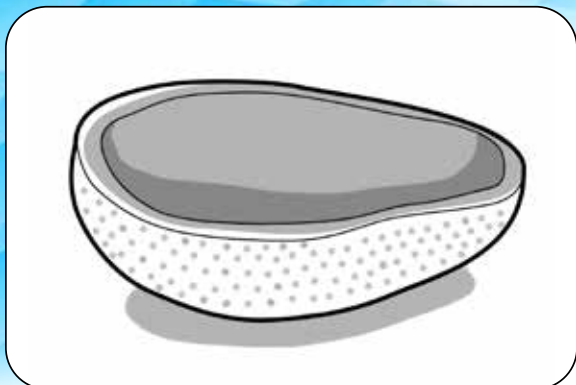

Cast residual foot. Also cast contralateral foot so the prosthesis can be built to match.

2. Positive Model

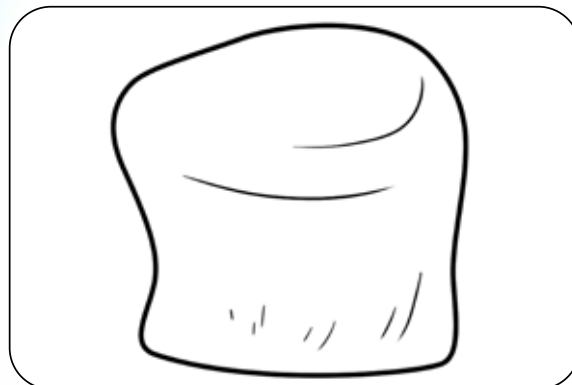

Make positive model of residual limb.

3. Distal Cushion

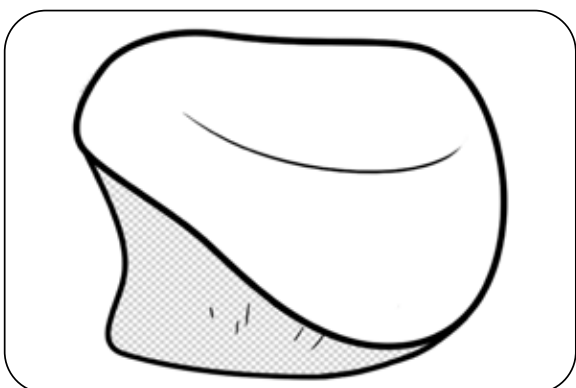

Mold 1/8" Impression Puff™ (25 Durometer Shore A EVA) for distal cushion (L5668).

4. Mold Socket

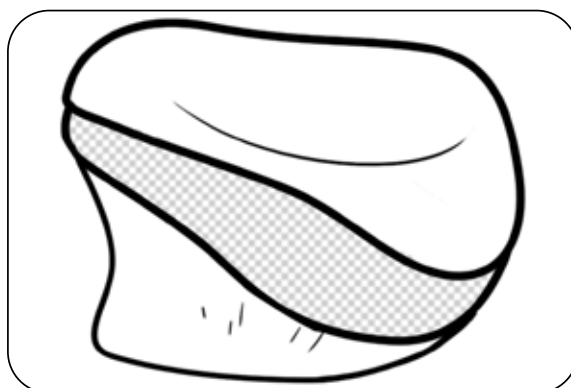

Mold 1/8" black co-polymer for the socket (included in base code L5020).

5. Post

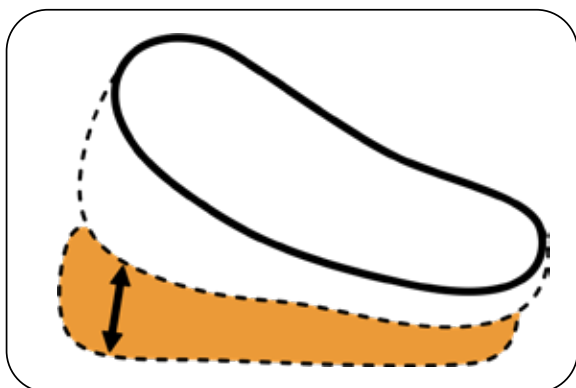

Post anterior aspect of socket to restore ankle neutral, and post posterior aspect if there is any residual LLD (see page 6).

6. Trim Lines

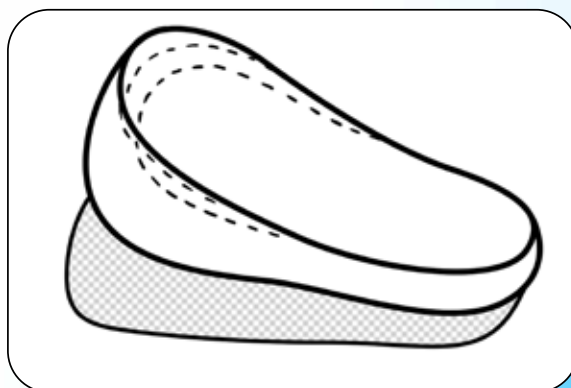

Trim anterior aspect of socket at start of filler prosthesis. Trim posterior aspect as a foot orthosis.

PROSTHESIS FABRICATION

7. Align to BlueROCKER

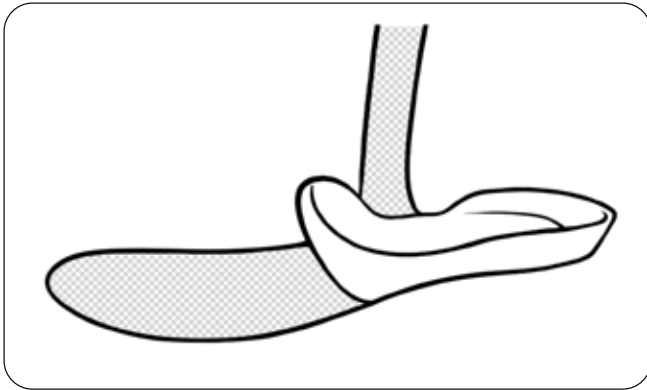

NOTE: Do NOT bill for the BlueROCKER®. This is an ultra light-weight tibial tubercle height carbon composite component that is covered by the base L5020 code. The ultra-lightweight code (L5785) is used at practitioner's discretion.

Align socket to BlueROCKER®, trimming to accommodate lateral strut if necessary.

8. Laminate Layers of Microcell Puff®

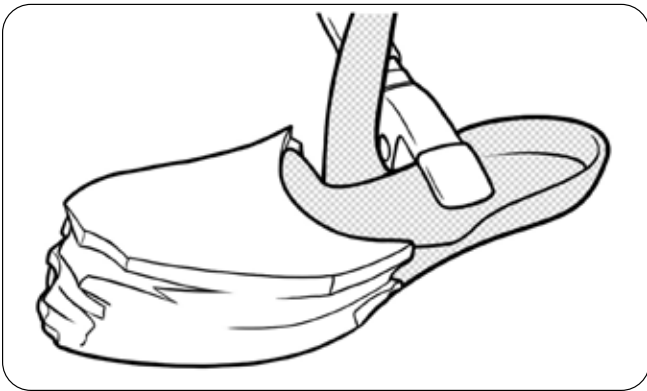

Laminate 1/4" layers of Microcell Puff Lite to build the filler prosthesis, conforming it to the rocker footplate.

9. Shape Foot and Socket

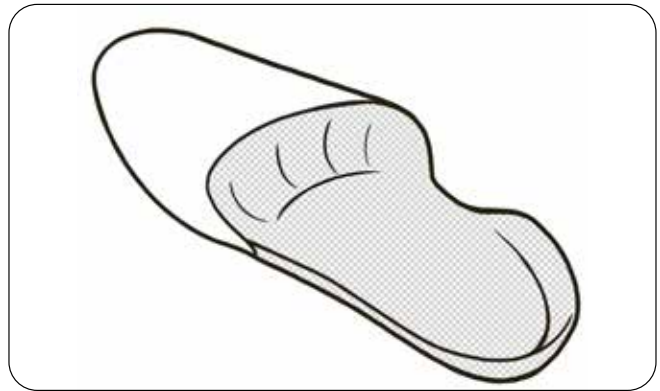

Shape to match the length, width and sagittal plane profile of the contralateral foot.

10. Add Interface

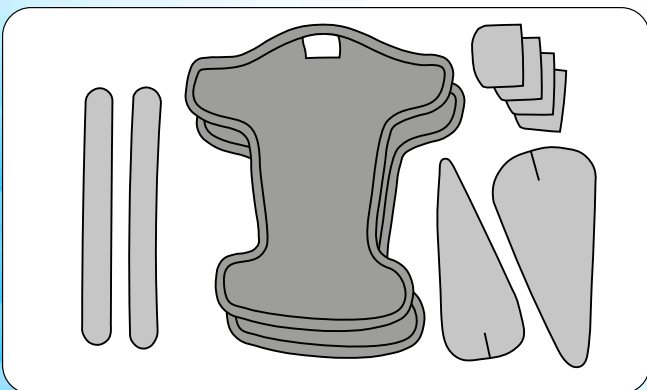

Line pretibial shell with SoftKIT, ComfortKIT, or Custom Interface to protect tibial crest.

11. Align Tibial Shell



Align pretibial shell to tibial crest for equal top to bottom pressure distribution before securing prosthesis to footplate.

SHOE SELECTION & EXERCISES

Shoe Selection

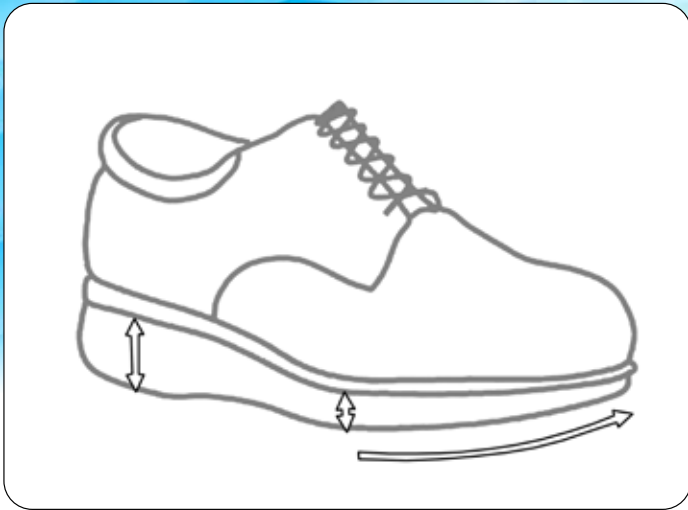

Footwear requirements include adequate heel/toe height differential, and toe rocker sole. A well constructed shoe (firm counter and shank) will produce better results. Flat-soled shoes (dress, court or deck shoes) are contraindicated.

Exercises

These exercises will help the wearer acclimate to their new environment by learning to take advantage of the energy return properties of the prosthesis. The importance of doing these exercises prior to walking cannot be overstated.

BABY SQUATS

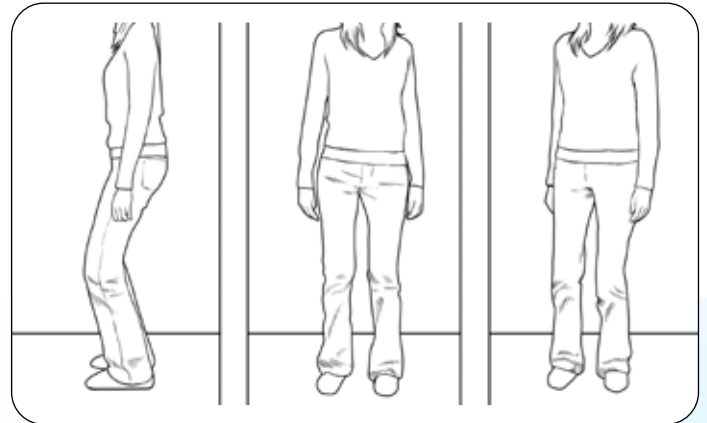

Baby squats (heels stay on the ground). Illustrated are sagittal, rotate right and rotate left squats.

TRI-PLANAR LUNGES

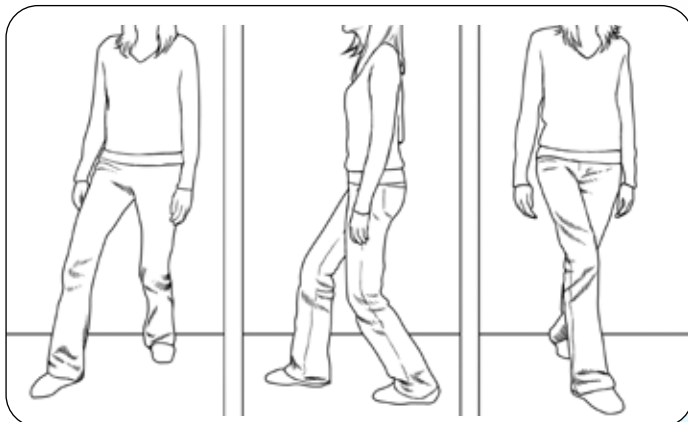

Step out, step ahead and cross-step, making sure both knees are flexed.

TRI-PLANAR HIP EXCURSION

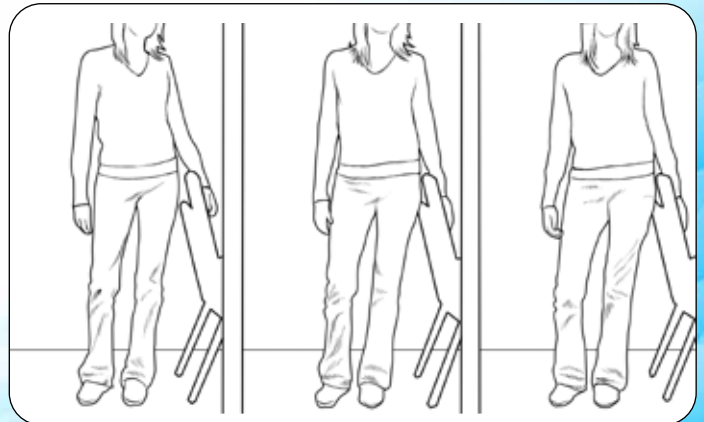

Determine excursion distance frontal plane, and then rotating forward and rotating to the back.

ACKNOWLEDGEMENTS

Robert H. Meier, CO, BOCO whose dedication, contribution, and love of the O&P industry made this illustrative guide possible.

David Scurti, CPO, for his early pioneering in partial foot prosthetic lever arm principles.

Dennis Amtower, CP, for continuous input on partial foot prosthesis fabrication.

Seamus Kennedy, BEng (Mech), CPed, for his expertise in foot biomechanics relating to the windlass mechanism and loss of propulsion secondary to partial foot amputation.

Ryan Feltman for the high quality professional illustrations.

BLUEROCKER® 2 ½
BLUEROCKER® 2.0



BlueROCKER® is recommended for all PFA shorter than 1st ray.

ToeOFF® 2 ½
ToeOFF® 2.0



For a stable ankle and no other proximal deficits, ToeOFF® may be considered for 1st ray amputations.

comfortKIT™

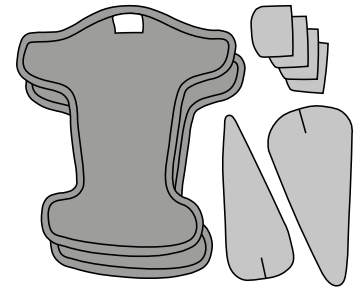

ComfortKIT™ is our premium 5mm memory foam interface. It is designed for the patient that requires added cushioning and a more intimate fit due to the shape of the tibia, skin condition, diabetes and/or activity level.

2 ½ Original Formula, 7mm Heel Height, Short Wings

2.0 Original Formula, 12-15mm Heel Height, Short Wings

	ToeOFF® 2 ½		BlueROCKER® 2 ½	
	w/D-ring	w/o D-ring	w/D-ring	w/o D-ring
XS-Left	28982 1010	28980 1010	28972 1010	28970 1010
XS-Right	28982 2010	28980 2010	28972 2010	28970 2010
S-Left	28982 1011	28980 1011	28972 1011	28970 1011
S-Right	28982 2011	28980 2011	28972 2011	28970 2011
M-Left	28982 1012	28980 1012	28972 1012	28970 1012
M-Right	28982 2012	28980 2012	28972 2012	28970 2012
L-Left	28982 1013	28980 1013	28972 1013	28970 1013
L-Right	28982 2013	28980 2013	28972 2013	28970 2013
XL-Left	28982 1014	28980 1014	28972 1014	28970 1014
XL-Right	28982 2014	28980 2014	28972 2014	28970 2014

	ToeOFF® 2.0		BlueROCKER® 2.0	
	w/D-ring	w/o D-ring	w/D-ring	w/o D-ring
XS-Left	28922 1010	28920 1010	28942 1010	28940 1010
XS-Right	28922 2010	28920 2010	28942 2010	28940 2010
S-Left	28922 1011	28920 1011	28942 1011	28940 1011
S-Right	28922 2011	28920 2011	28942 2011	28940 2011
M-Left	28922 1012	28920 1012	28942 1012	28940 1012
M-Right	28922 2012	28920 2012	28942 2012	28940 2012
L-Left	28922 1013	28920 1013	28942 1013	28940 1013
L-Right	28922 2013	28920 2013	28942 2013	28940 2013
XL-Left	28922 1014	28920 1014	28942 1014	28940 1014
XL-Right	28922 2014	28920 2014	28942 2014	28940 2014

Original Formula, 12-15mm Heel Height, Long Wings

	ToeOFF® Original Model w/o D-ring	ToeOFF® Short w/o D-ring	BlueROCKER® Original Model w/o D-ring
XS-Left	28375 1010	N/A	28405 1010
XS-Right	28375 2010	N/A	28405 2010
S-Left	28375 1011	28380 1011	28405 1011
S-Right	28375 2011	28380 2011	28405 2011
M-Left	28375 1012	28380 1012	28405 1012
M-Right	28375 2012	28380 2012	28405 2012
L-Left	28375 1013	28380 1013	28405 1013
L-Right	28375 2013	28380 2013	28405 2013
XL-Left	28375 1014	N/A	28405 1014
XL-Right	28375 2014	N/A	28405 2014

AllardUSA@DEC2019